

**marzocchi**  
WWW.MARZOCCHI.COM

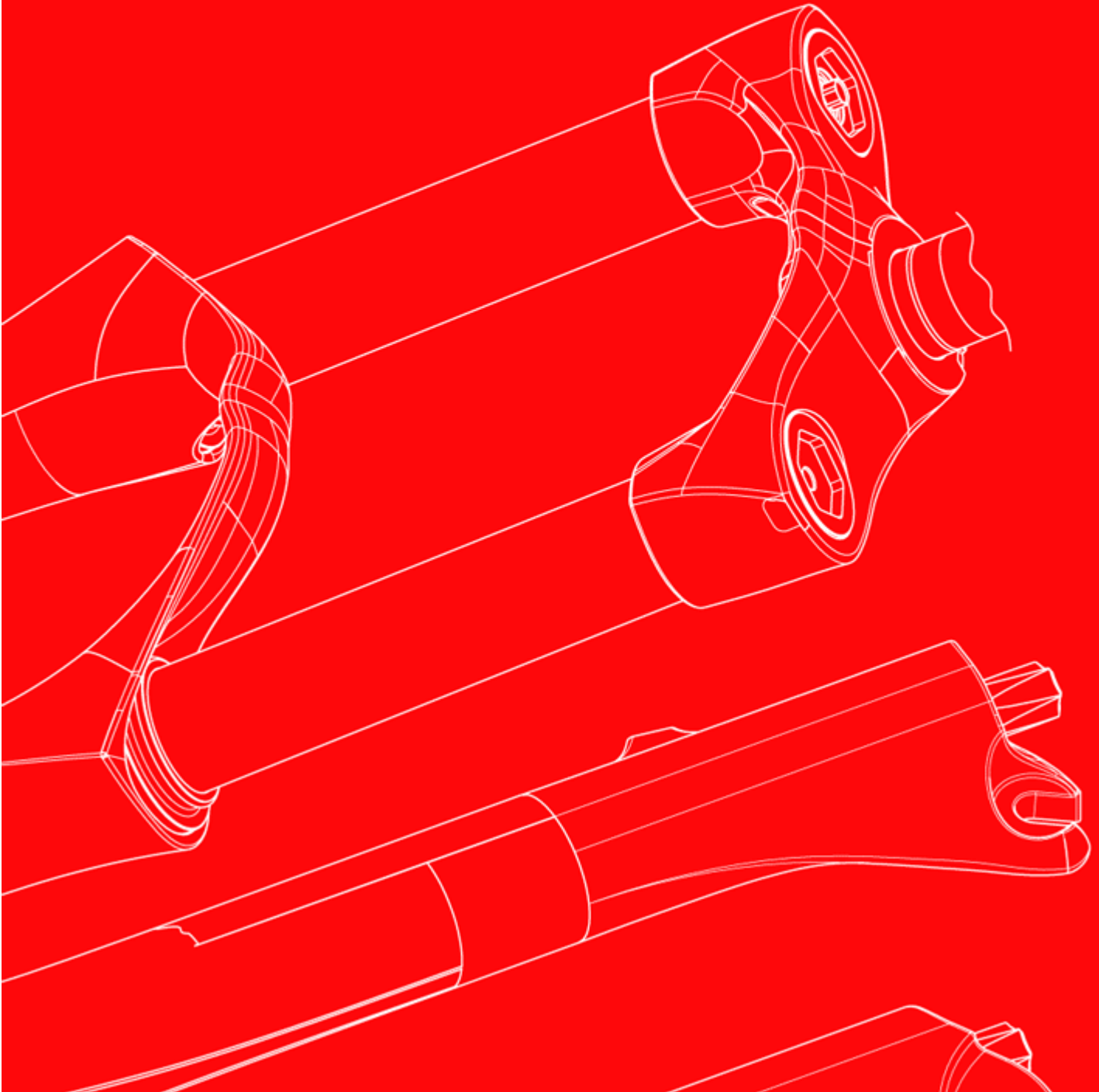

# 2006 - Gran Fondo 2

Technical instructions

**Exploded view - Gran Fondo 2 - 105**

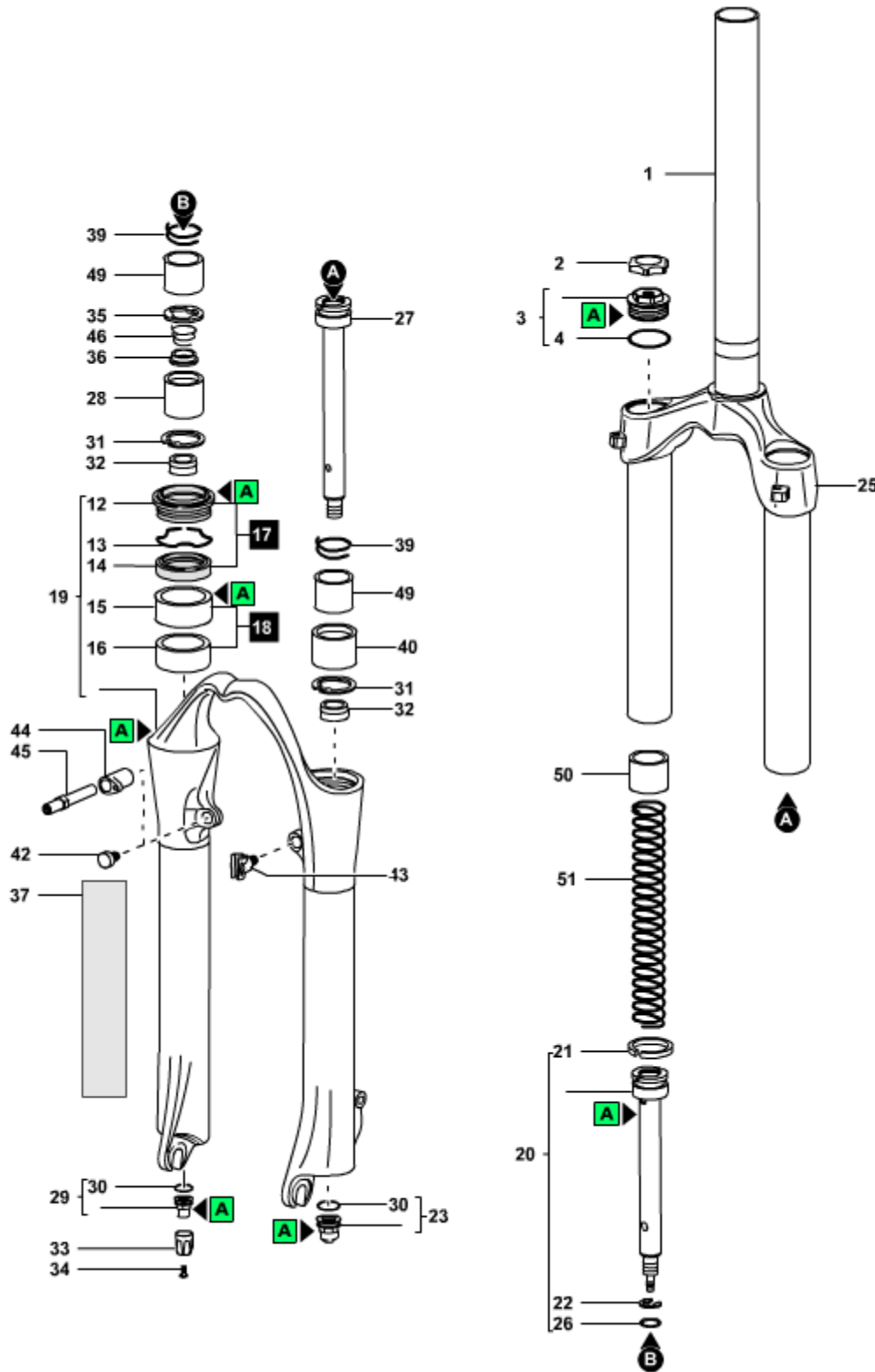

Rif. Code	Quantity
1 5081009-TW	1
2 549072AD	2
4 528320-TW	2
12 533301	2
13 523261	2
14 528172NOK>B	2
15 538113	2
16 538112	2
17 850690	0
18 850779/C	0
19 5321182RS/R>A	1
19 5321182RR/R>A	1
19 5321182SS/R>A	1
19 5321182SR/R>A	1
20 8031196/C	1
21 524127>A	1
22 523011	1
23 5321130>B	1
26 528223	1
27 556541/C	1
28 509107	1
29 5321129>A	1
30 528046	2
31 523270	2
32 512098>C	2
33 549067	1
34 520313	1
35 522069	1
36 516106	1
37 547745-TW	1
37 547747-TW	1
37 547744-TW	1
37 547746-TW	1
39 5141420/C	1
42 5321106	1
43 5321158>A	1
44 5321114>A	2
45 5321115QF>A	2
46 5141230	1
49 5181268	2
50 5181268	1
51 5141566-TW	1

**Gran Fondo 2 - 105 - Oil levels**

Position	Oil type	Quantity (cc)
Right fork leg	SAE 7,5 - 550013	125
Left fork leg	SAE 7,5 - 550013	125

**Spare part list - Gran Fondo 2 - 105**

Rif.	Code	Description	Q.ty in the model
1	5081009-TW	<b>FORK STEM FPM040</b>	1
2	549072AD	<b>ALUMINUM BLACK KNOB</b>	2
4	528320-TW (replaces EXR FAA072)	<b>O RING (P22)FAA072</b>	2
12	533301	<b>DUST SEAL DIA.30</b>	2
13	523261	<b>STOP RING</b>	2
14	528172NOK>B	<b>OIL SEAL DIA.30</b>	2
15	538113	<b>UPPER BUSHING DIA 30</b>	2
16	538112	<b>LOWER BUSHING DIA 30</b>	2
17	850690	<b>OIL SEAL KIT M/ARCH</b>	0
18	850779/C	<b>BUSHINGS DIA 30 KIT</b>	0
19	5321182RS/R>A	<b>ECO BLACK-MONOLITE UNIT</b>	1
19	5321182RR/R>A	<b>FLAT BLACK MONOLITE UNIT 04</b>	1
19	5321182SS/R>A	<b>MAGNUM GREY GLOSS-MONOL.UNIT</b>	1
19	5321182SR/R>A	<b>SILVER DUST-MONOLITE UNIT</b>	1
20	8031196/C	<b>PUMPING ROD MXPRO 04-105/120</b>	1
21	524127>A	<b>PISTON RING</b>	1
22	523011	<b>STOP RING</b>	1
23	5321130>B	<b>FOOT NUT UNIT</b>	1
26	528223	<b>O-RING</b>	1
27	556541/C	<b>PUMPING ROD MXPRO 04-105/120</b>	1
28	509107	<b>FERRULE</b>	1
29	5321129>A	<b>FOOT NUT UNIT</b>	1
30	528046	<b>O-RING</b>	2
31	523270	<b>STOP RING</b>	2
32	512098>C	<b>FOOT BUFFER</b>	2
33	549067	<b>ADJUSTER</b>	1
34	520313	<b>SCREW</b>	1
35	522069	<b>WASHER 3P 26.8X2 FE D32PIF.</b>	1
36	516106	<b>VALVE D14,4 PLASTIC</b>	1
37	547745-TW	<b>LABEL L (MA11) GRAY FEM013-22</b>	1
37	547747-TW	<b>LABEL L (MA12) BLACK FEM013-24</b>	1
37	547744-TW	<b>LABEL R (MA11) GRAY FEM013-21</b>	1
37	547746-TW	<b>LABEL R (MA12) BLACK FEM013-23</b>	1
39	5141420/C	<b>REB.SPRINGS 15MM KIT K=4.5</b>	1
42	5321106	<b>RUBBER</b>	1
43	5321158>A	<b>CABLE GUIDE</b>	1
44	5321114>A (replaces 5321114)	<b>PIN ADAPTOR</b>	2
45	5321115QF>A (replaces 5321115QF)	<b>CANTILEVER PIN</b>	2
46	5141230	<b>VALVE SPRING</b>	1
49	5181268	<b>PRELOAD SLEEVE 15MM LONG</b>	2
50	5181268	<b>PRELOAD SLEEVE 15MM LONG</b>	1
51	5141566-TW	<b>MAIN SPRING FEP209</b>	1

**Exploded view - Gran Fondo 2 - 120**

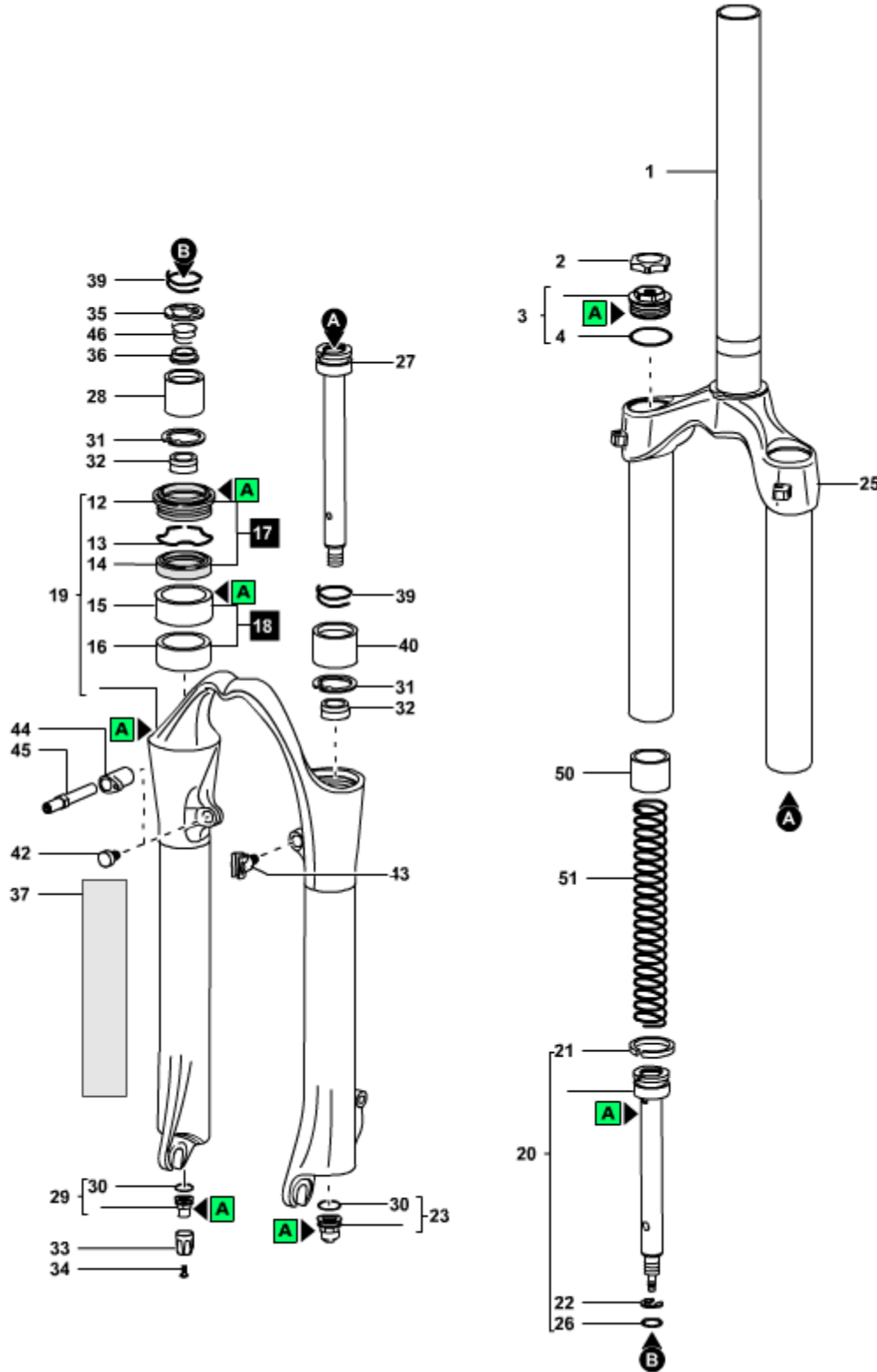

Rif. Code	Quantity
1 5081009-TW	1
2 549072AD	2
4 528320-TW	2
12 533301	2
13 523261	2
14 528172NOK>B	2
15 538113	2
16 538112	2
19 5321182RS/R>A	1
19 5321182RR/R>A	1
19 5321182SS/R>A	1
19 5321182SR/R>A	1
20 8031196/C	1
21 524127>A	1
22 523011	1
23 5321130>B	1
26 528223	1
27 556541/C	1
28 509107	1
29 5321129>A	1
30 528046	2
31 523270	2
32 512098>C	2
33 549067	1
34 520313	1
35 522069	1
36 516106	1
37 547745-TW	1
37 547747-TW	1
37 547744-TW	1
37 547746-TW	1
39 5141420/C	1
42 5321106	1
43 5321158>A	1
44 5321114>A	2
45 5321115QF>A	2
46 5141230	1
50 5181268	1
51 5141565-TW	1

**Gran Fondo 2 - 120 - Oil levels**

Position	Oil type	Quantity (cc)
Right fork leg	SAE 7,5 - 550013	125
Left fork leg	SAE 7,5 - 550013	125

**Spare part list - Gran Fondo 2 - 120**

Rif.	Code	Description	Q.ty in the model
1	5081009-TW	<b>FORK STEM FPM040</b>	1
2	549072AD	<b>ALUMINUM BLACK KNOB</b>	2
4	528320-TW (replaces EXR FAA072)	<b>O RING (P22)FAA072</b>	2
12	533301	<b>DUST SEAL DIA.30</b>	2
13	523261	<b>STOP RING</b>	2
14	528172NOK>B	<b>OIL SEAL DIA.30</b>	2
15	538113	<b>UPPER BUSHING DIA 30</b>	2
16	538112	<b>LOWER BUSHING DIA 30</b>	2
19	5321182RS/R>A	<b>ECO BLACK-MONOLITE UNIT</b>	1
19	5321182RR/R>A	<b>FLAT BLACK MONOLITE UNIT 04</b>	1
19	5321182SS/R>A	<b>MAGNUM GREY GLOSS-MONOL.UNIT</b>	1
19	5321182SR/R>A	<b>SILVER DUST-MONOLITE UNIT</b>	1
20	8031196/C	<b>PUMPING ROD MXPRO 04-105/120</b>	1
21	524127>A	<b>PISTON RING</b>	1
22	523011	<b>STOP RING</b>	1
23	5321130>B	<b>FOOT NUT UNIT</b>	1
26	528223	<b>O-RING</b>	1
27	556541/C	<b>PUMPING ROD MXPRO 04-105/120</b>	1
28	509107	<b>FERRULE</b>	1
29	5321129>A	<b>FOOT NUT UNIT</b>	1
30	528046	<b>O-RING</b>	2
31	523270	<b>STOP RING</b>	2
32	512098>C	<b>FOOT BUFFER</b>	2
33	549067	<b>ADJUSTER</b>	1
34	520313	<b>SCREW</b>	1
35	522069	<b>WASHER 3P 26.8X2 FE D32PIF.</b>	1
36	516106	<b>VALVE D14,4 PLASTIC</b>	1
37	547745-TW	<b>LABEL L (MA11) GRAY FEM013-22</b>	1
37	547747-TW	<b>LABEL L (MA12) BLACK FEM013-24</b>	1
37	547744-TW	<b>LABEL R (MA11) GRAY FEM013-21</b>	1
37	547746-TW	<b>LABEL R (MA12) BLACK FEM013-23</b>	1
39	5141420/C	<b>REB.SPRINGS 15MM KIT K=4.5</b>	1
42	5321106	<b>RUBBER</b>	1
43	5321158>A	<b>CABLE GUIDE</b>	1
44	5321114>A (replaces 5321114)	<b>PIN ADAPTOR</b>	2
45	5321115QF>A (replaces 5321115QF)	<b>CANTILEVER PIN</b>	2
46	5141230	<b>VALVE SPRING</b>	1
50	5181268	<b>PRELOAD SLEEVE 15MM LONG</b>	1
51	5141565-TW	<b>MAIN SPRING FEP208</b>	1

**Technical characteristics: Technical characteristics**

---

Single-crown fork with  $\varnothing$  30mm legs.

**Available travels:** 105 mm, 120 mm.

**Right fork leg damping element:** spring (air pre-load).

**Left fork leg damping element:** air.

**Right fork leg damping system:** SSVF pumping element with external rebound adjustment.

**Left fork leg damping system:** pumping element.

The stanchion tubes are pressed into the crown with a cryogenic process.

Lubrication and cooling of the parts subject to friction with a specially formulated oil.

**Steer tube:** steel or (optional) aluminium, 1-1/8", threadless.

**Crown:** aluminium alloy forged and CNC machined.

**Stanchions:** anodised aluminium.

**One-piece assembly:** made of magnesium alloy cast and CNC machined for lighter weight and more stiffness.

**Sliding bushings:** made of friction-free and wear-free material.

**Seals:** computer designed oil seals that guarantee maximum seal in any condition.

**Oil:** specially formulated oil that prevents foam and keeps the viscosity unchanged while offering high performance; free from static friction.

**Dropout type:** standard.

**Disk brake mount:** XC International Standard for 6" disk.

**V-Brake fit:** removable.

**Max wheel size:** 2.2" x 26".

## Warnings: Instructions for use

---

MARZOCCHI forks are based on an advanced technology coming from the company's years long experience in the professional mountain bike industry.

For the best results, we recommend inspecting and cleaning the area below the dust seal and the stanchion tube after every use and lubricating the parts with some silicone oil.

MARZOCCHI forks usually offer the best performances since the very first rides. Notwithstanding this, a short running-in period may be necessary (5-10 hours) to adjust the internal couplings. This precaution will lengthen your fork's life and guarantee its best performances.

We recommend changing the oil at least every 100 hours.

The forks with a polished finish must be treated periodically with polishing paste to keep the exterior shining like new.

## Warnings: General safety rules

---

After disassembling the forks, always use new, original Marzocchi seals when reassembling.

To tighten two bolts or nuts that are near each other, always follow the sequence 1-2-1, and tighten to the required tightening torque.

Before reassembly, wash all new and old components and dry them with some compressed air, making sure there are neither breaks nor burrs.

Never use flammable or corrosive solvents when cleaning the forks, as these could damage the fork's seals. If you must use a solvent, use biodegradable detergents that are not corrosive, non-flammable, or have a high flash point.

Before reassembling, always lubricate those components that are in contact with the fork's oil.

If you are planning not to use your forks for a long period of time, always lubricate those components that are in contact with the fork's oil.

Always collect and keep any lubricants, solvents, or detergents, which are not completely biodegradable in the environment. These materials should be kept in appropriate containers, and disposed of according to local laws.

Always grease the seal lips before reassembling.

All of the components of Marzocchi forks require the use of metric tools. Use only metric tools. Imperial (US) tools may have similar sizes, but can damage the bolts, making them impossible to loosen or tighten.

When using a screwdriver to assemble or disassemble metal stop rings, O-rings, sliding bushings, or seal segments, avoid scratching or cutting the components with the screwdriver tip.

Do not carry out any maintenance and / or adjustment operations that are not explained in this manual.

Only use original Marzocchi spare parts.

Before servicing the fork, we recommend washing the fork thoroughly.

Work in a clean, organized, and well-lit place. If possible, avoid servicing your forks outdoors.

Carefully check to see that your work area is free of dust and metal shavings from any component of the forks.

Never modify your fork in any way.

## Warnings: Fitting the fork onto the frame

---

The fork is supplied with "A-Head Set" steer tube to be cut to size according to frame being used.

Fitting the fork onto the bike frame is a very delicate operation that must be carried out at one of our service centres only.

The assembling on the frame and the adjustment of the steer tube must be carried out following the instructions of the steering set manufacturer.

**A wrong installation can be dangerous for the rider.**

**Marzocchi does not guarantee the assembly and accepts no liability for damage and/or accidents arising from a wrong installation.**

The steer tube must be pressed into the crown; its replacement must be carried out by one of our service centres using the adequate tools.

**A wrong installation of the steer tube into the crown may cause the rider to lose the control of the bike and lead to serious personal injury.**

## Warnings: Installing the disk brake

---

Installing the brake system is a delicate and critical operation that must be carried out by an authorized Marzocchi Service Center.

Marzocchi is not responsible for the installation and accepts no liability for damage and/or accidents arising from this operation.

Improper installation of a disk brake system can overstress the caliper mountings, which may cause the caliper mountings to break, resulting in loss of control of the bicycle, an accident, personal injury, or death. Be sure that the brake system installation is also performed in strict compliance with the instructions provided by the brake system manufacturer.

**Improper installation can result in an accident, personal injury, or death.**

Use only brake systems that comply with the forks specifications.

**If the fork comes standard with V-brake mounts, remove such mounts and install the cable guide (A) on the left side and cap (B) on the right side.**

**After installation always check that the brake tube is correctly fixed to the special mount (A).**

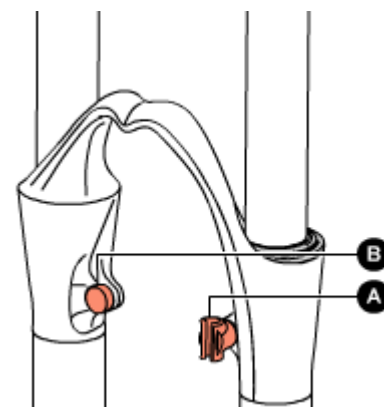

The brake cable must never touch the crown and stanchions.

### Warnings: Installing the V-brake

---

Installing the brake system is a very delicate operation that must be carried out at our specialised service centres only. Marzocchi does not guarantee the installation and accepts no liability for damage and/or accidents arising from a wrong installation.

**Improper installation of the disk brake system can overstress the caliper mountings, which may break. The installation of the brake system must be carried out following the instructions of the brake system manufacturer. Improper installation can be dangerous for the rider.**

Use only brake systems in accordance with the fork specifications.

**If the fork does not come standard with V-brake mounts, after removing the cable guide (A) and the disk brake mount cap (B), install the adapter (A) and the bolt (D) on both legs, check that the adapter is correctly oriented as shown and tighten the bolt to the recommended tightening torque (9 Nm  $\pm$ 1).**

**On the thread of bolts (D) a special anti-unscrewing treatment has been applied; as a result, the removed bolts cannot be re-used as they lose such treatment.**

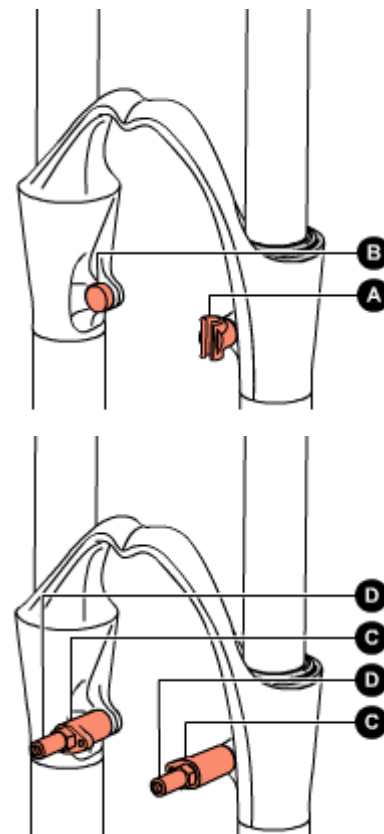

### Warnings: Assembling the wheel

---

**Install the wheel following the instructions of the manufacturer.**

For a correct operation of the fork, install the wheel and proceed with the following checks:

Check the correct fork-wheel alignment by fully compressing the fork a few times. The wheel should not come into contact with any parts of the fork.

Lift the front wheel above the ground; turn the wheel a few times to verify the correct alignment and the distance from the disk brake or the V-brake pads. Read the instructions of the brake system manufacturer for the correct specifications.



### Dismantling: Removing the top caps

---

Put the fork in the vice in vertical position, fixing it by the dropouts.

Remove the protection cap (1).

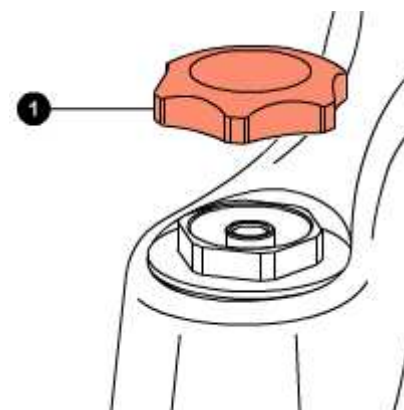

Using a small pin screwdriver, blow the air off the fork leg, pushing on the air valve.

Fully unscrew lock cap (2) with a 21mm socket spanner.

Remove lock cap (2).

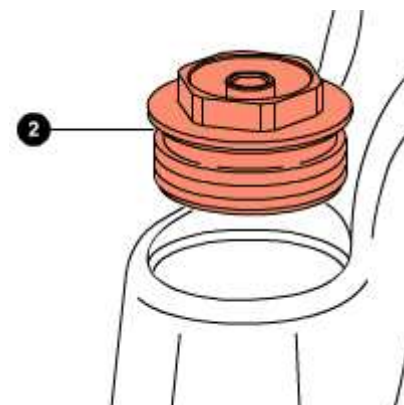

### Dismantling: Draining the oil

---

Remove the preload tube (1) and spring (2) from the right leg.

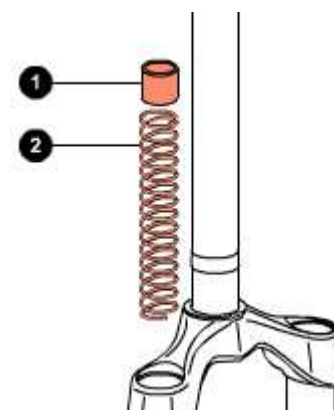

Free the fork from the vice and tip it into a container of a suitable size to drain the oil; compress the fork a few times to help the oil flow out.

**Do not pour used oils on the ground.**



### Dismantling: Breaking down the steering crown unit / arch-slider assembly

---

**Use the special spanner to remove the bottom nuts. Do not use other tools.**

Turn the arch-slider assembly upside down.

With a 2mm Allen wrench loosen the screw (5) fixing the rebound adjustment knob (6) from the right leg. Remove the rebound adjustment knob (6).

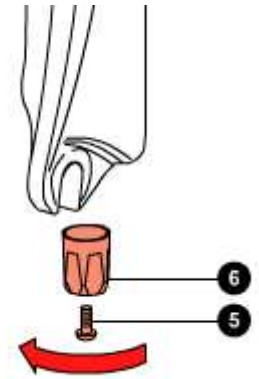

Using the special 12mm spanner (A), loosen the right bottom nut (7).

Pull out the bottom nut (7) complete with O-ring (8).

**Take great care not to damage the O-ring on the pumping element rod.**

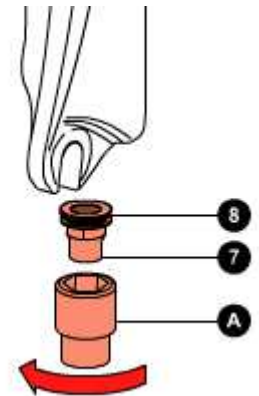

Using the special 12mm spanner (A), loosen the left bottom nut (1).

Pull out the left bottom nut (1) complete with O-ring (2).

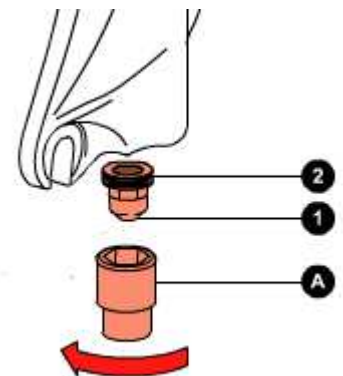

Pull the crown-stanchion unit (3) off the arch-slider assembly (4).

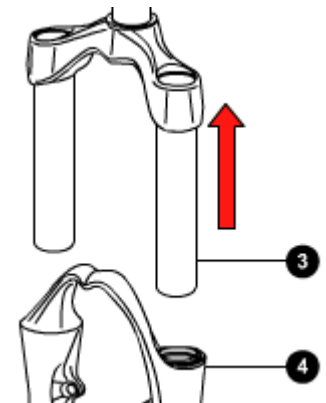

### **Dismantling: Dismantling the right pumping element and valve**

Remove the bottom pad (1).

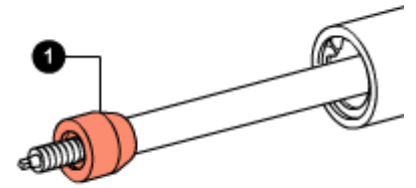

Using the special round-nose pliers, remove stop ring (2).

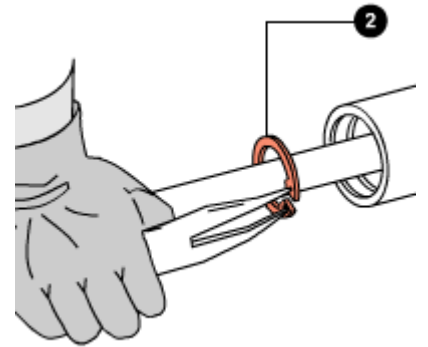

Pull out the pumping element (3) complete with rebound spring and valve.

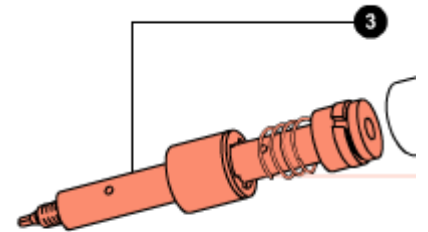

Remove bushing (4), the conical spring (11), valve (5) and the three-point ring (6) from the pumping element.

Remove the preload tube (9) (*only for models with 105mm travel*).

Remove the rebound spring (7).

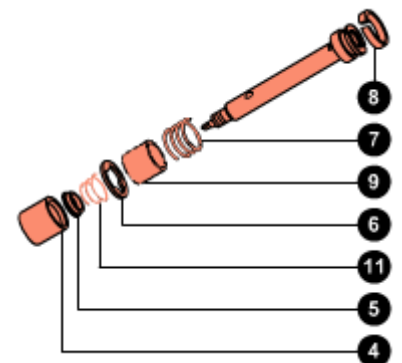

If the piston segment (8) is damaged, you can prize it off with a small flat-tip screwdriver.

### **Dismantling: Removing the left pumping element**

Remove the bottom pad (1).

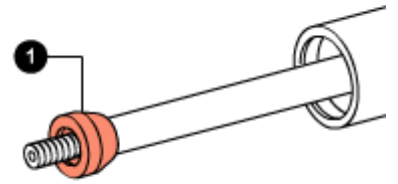

Pull out the pumping element (3) complete with rebound spring and valve.

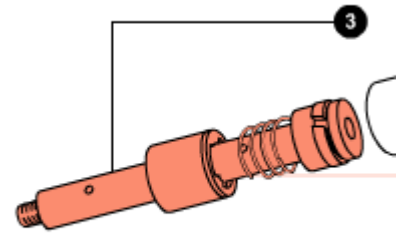

Remove bushing (4), the preload tube (9) (*only for models with 105mm travel*) and the rebound spring (7) from the pumping element.

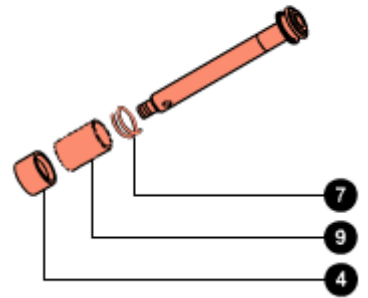

### Dismantling: Removing the seals

Prize the dust seal (1) off its seat with a small flat-tip screwdriver.

**Take great care not to damage the internal surfaces of the one-piece assembly while removing the dust seal.**

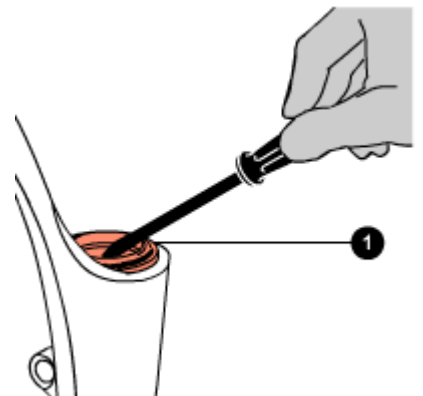

With the same screwdriver, prize off the metal stop ring (2).

**Take great care not to damage the internal surfaces of the one-piece assembly while removing the stop ring.**

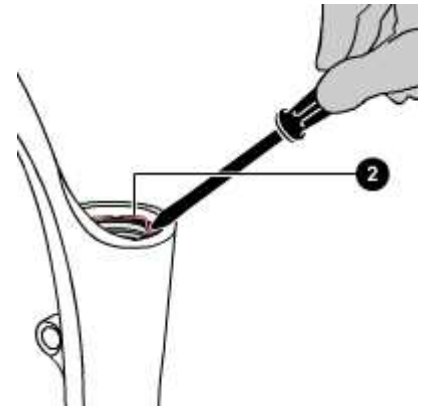

Protect the upper part of the slider with the special tool (A).

With a screwdriver, prize off the sealing ring (3).

Remove the sealing ring (3).

**Take great care not to damage the internal surfaces of the one-piece assembly while removing the sealing ring.**

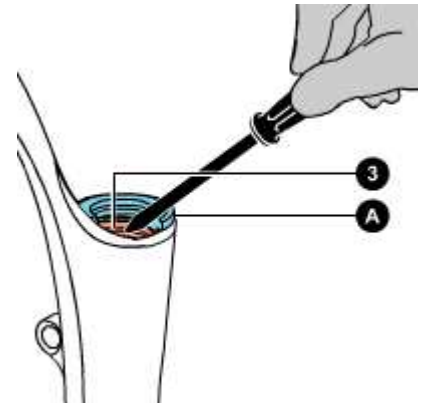

**The old sealing rings and dust seals must not be used again.**

### Dismantling: Removing the guide bushes

**Use the special extractor to remove the guide bushes. Do not use other tools.**

Fit the aluminium bush (A) to the extractor keeping the side with smaller diameter towards the edge opposite to striker (D).

Fit the extraction washer (B) with a white finish to the extractor.

**During use, remove the non-used washer from the extractor.**

**Remove first the top bushes, then the bottom bushes.**

Fit the extraction washer keeping the blunt side towards the threaded grub screw (C) fixed crosswise on to the main rod as shown.

The slot in the rod lets the extraction washer swing inside the rod itself.

Insert the extractor in the arch-slider assembly from the side of washer (B) as shown.

The slot in the extractor rod will let the washer pass underneath the bush to be extracted.

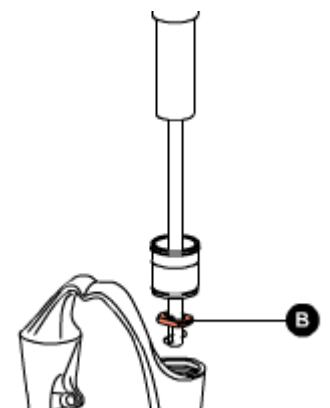
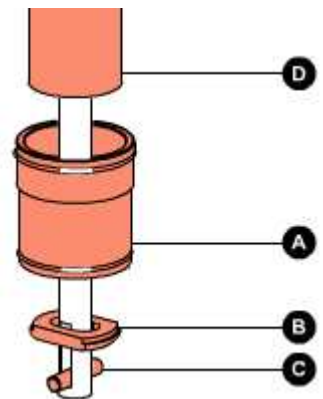

Pull the extractor rod so that the upper face of the washer stops against the lower face of the guide bush.

Insert the aluminium bush (A) in the seat of the sealing ring.

While holding the main rod in position, the aluminium bush will drive the guide bushes during extraction.

Using striker (D) knock out and extract the guide bush (1).

Remove the guide bush (1) from the extractor.

Repeat the steps above to remove the bottom guide bush.

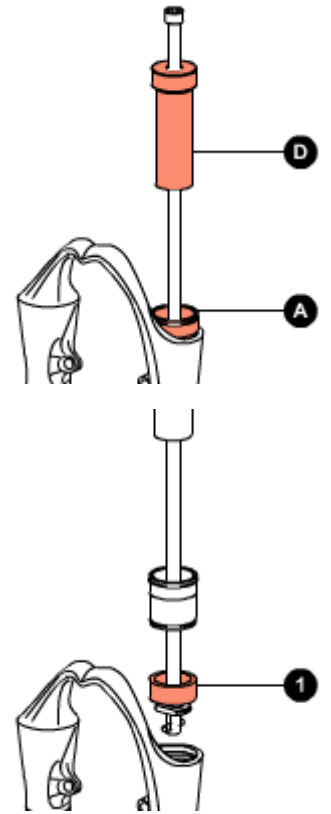

### Assembling: Assembling the guide bushes

Insert the guide bushes using the special introducers (short type for the top bush and long type for the bottom bush, both with a black finish). Do not use other tools.

Fit first the bottom bushes, then the top bushes.

Using the long introducer (A) fit the bottom bush (1).

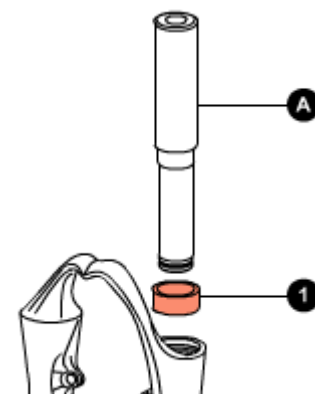

Using a hammer knock the introducer (A) into the arch-slider assembly.

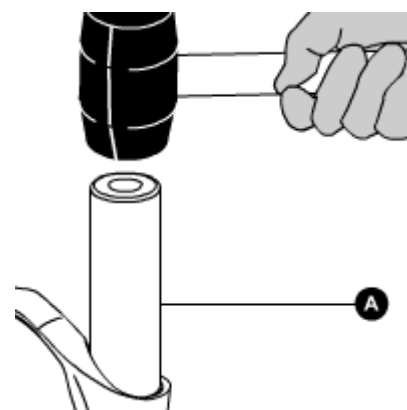

Using the short introducer (B) fit the top bush (2).

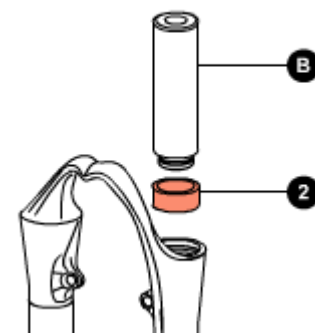

Using a hammer knock the introducer (B) into the arch-slider assembly.

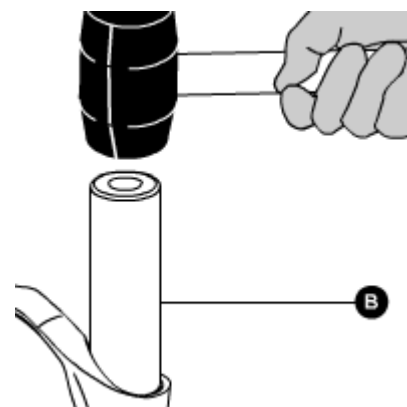

### Assembling: Assembling the seals

Smear the dust seal and the sealing ring with some grease.  
Insert the sealing ring (3) in its seat with the special introducer (A).

Using a hammer, knock in introducer (A) and drive the sealing ring home into the arch-slider assembly.

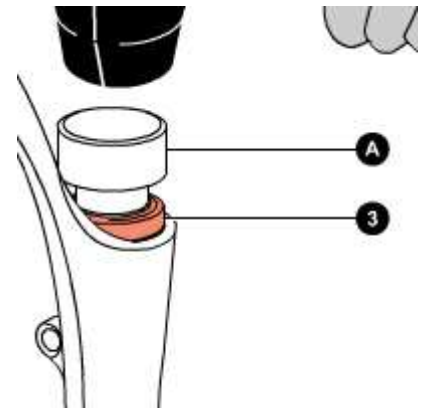

Using a small flat-tip screwdriver, fit the stop ring (2) and check that it fits perfectly into its groove. **Take great care not to damage the internal surfaces of the one-piece assembly when fitting the stop ring.** The dust seals shall be refitted when reassembling the crown-stanchion unit / arch-slider assembly.

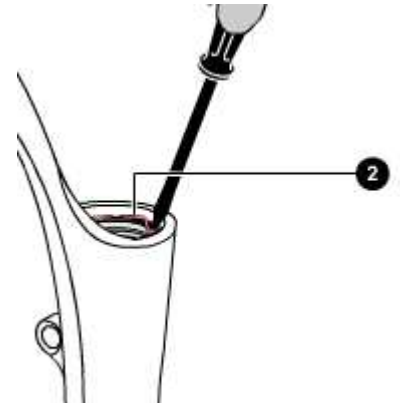

### Assembling: Assembling the right pumping element and valve

Replace the segment (8) of the pumping element, if necessary.

Insert the rebound spring (6) and the preload tube (5) (*only on models with 105mm travel*) into the piston rod.

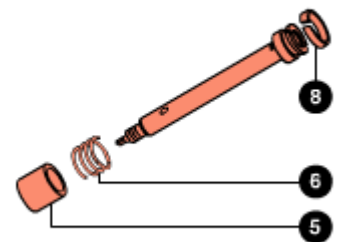

Assemble the valve unit in this order: bushing (4), valve (5), conical spring (11), three-point ring (6), and check that the parts are oriented as shown.

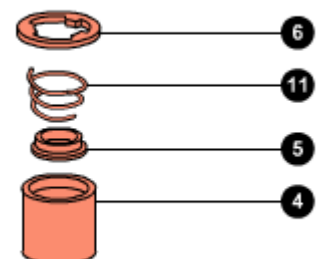

Insert the pre-assembled valve in the piston rod from the three-point ring side as shown. Insert the valve and the pumping element (3) into the stanchion.



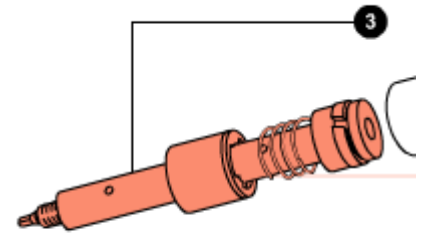

**Take great care not to damage the segment and if necessary use a small flat-tip screwdriver to help the piston of the pumping element into the stanchion.**

Using the special round-nose pliers, mount the stop ring (2) and check it fits perfectly into its groove.

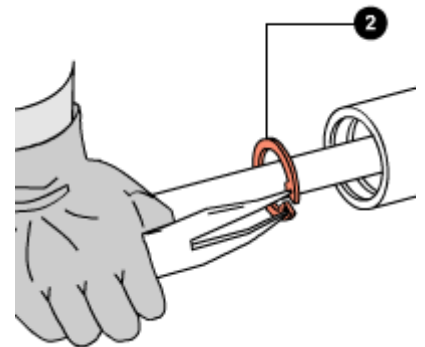

Fit the bottom pad (1) to the pumping element rod.

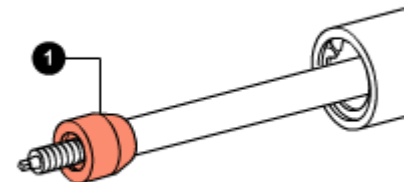

### Assembling: Assembling the left pumping element

Insert the rebound spring (7), the preload tube (9) (*only on models with 105mm travel*) and bushing (4) (through the hole with smaller diameter) into the piston rod.

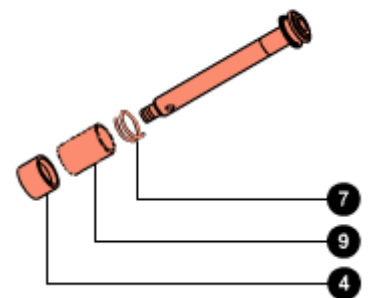

Insert the bushing in the piston rod through the hole with smaller diameter.  
Insert the pumping element (3) into the stanchion.

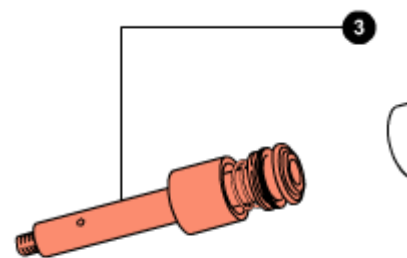

**Take great care not to damage the segment and if necessary use a small flat-tip screwdriver to help the piston of the pumping element into the stanchion.**

Using the special round-nose pliers, mount the stop ring (2) and check it fits perfectly into its groove.

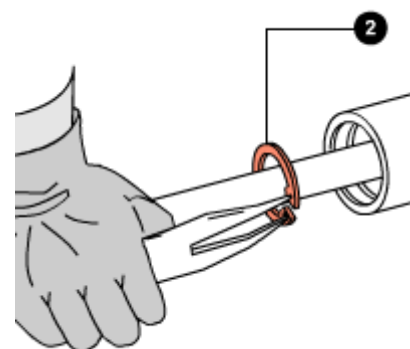

Fit the bottom pad (1) to the pumping element rod.

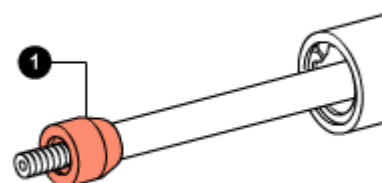

### **Assembling: Reassembling the steering crown unit / arch-slider assembly**

**A special spanner shall be used to assemble the bottom nuts. Do not, at any times, use other tools.**

Fit both dust seals (11) to the stanchions.

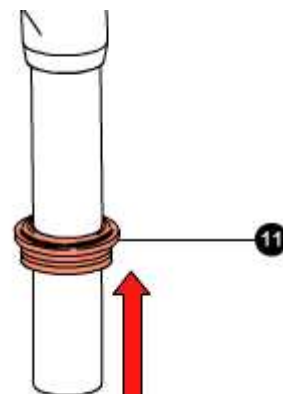

Insert the crown-stanchion unit (3) in the arch-slider assembly (4).

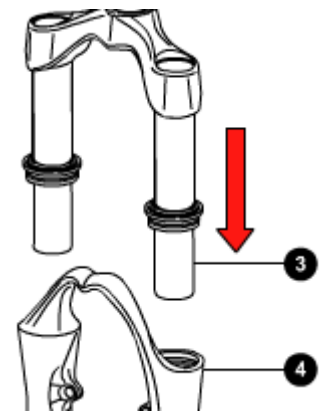

With the special 12mm spanner (A), tighten the right bottom nut (7) complete with O-ring (8) to the recommended tightening torque (**10 Nm ± 1**).

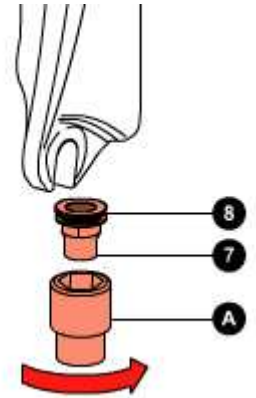

Fit the rebound adjusting knob (6) to the right leg.

**Take great care not to damage the O-ring fitted to the end of the pumping element rod.**

Tighten the fixing screw (5) of the adjusting knob to the recommended tightening torque (**2 Nm ± 0.5**).

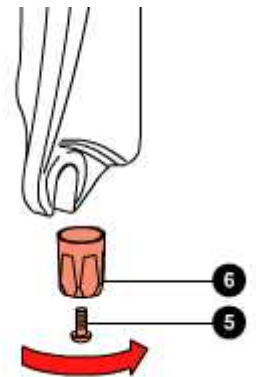

Using the special 12mm spanner, tighten the left bottom screw (1) complete with O-ring (2) to the recommended tightening torque (**10 Nm ± 1**).

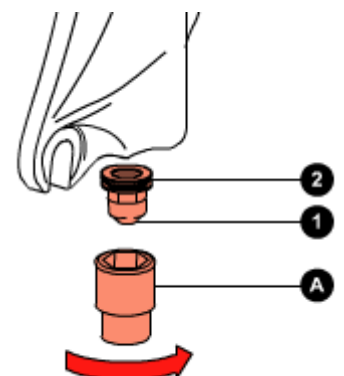

Using introducer (A) insert the dust seals (11) in their seats.

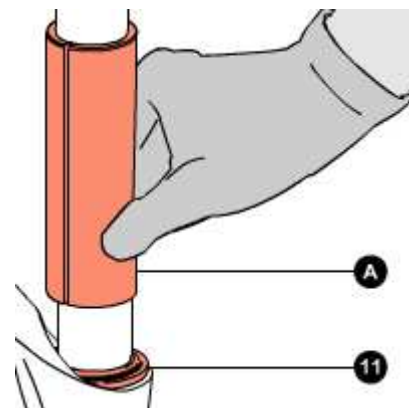

### Assembling: Filling with oil

Block the fork in the vice, in perfectly vertical position.

Lower the crown-stanchion unit on the arch-slider assembly.

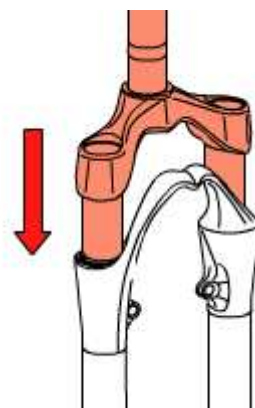

In a graduated recipient, prepare the quantity of oil to pour into the fork leg (see table).

Pour roughly 1/3 of the oil required into each stanchion, then pump the fork a few times to eliminate any traces of air.

Pour the rest of oil in.

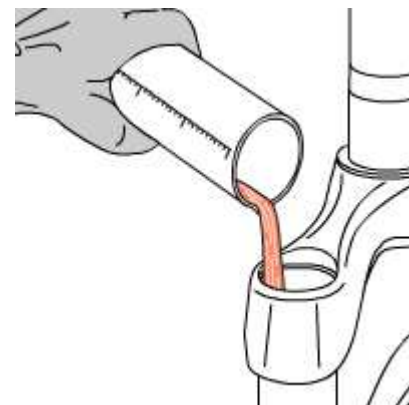

**A lower or higher volume or a type of oil other than the one recommended can change the behaviour of the fork in every phase.**

Lift the crown-stanchion unit on the arch-slider assembly.

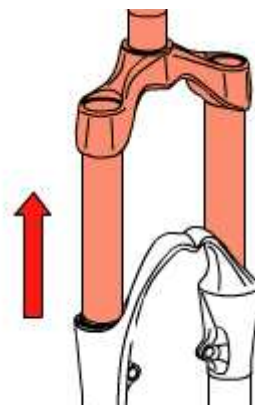

Remove the preload tube (1) and spring (2) from the right leg.

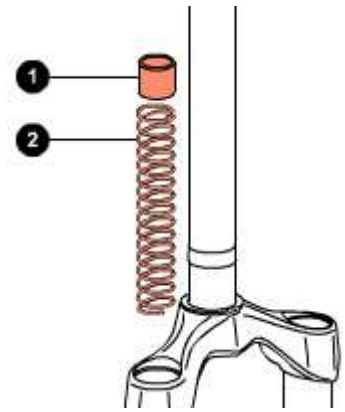

### Assembling: Mounting the top caps

Put the fork in the vice in vertical position, fixing it by the dropouts.

Check that O-ring is not damaged.

Using the 21mm socket spanner, tighten cap (2) to the recommended tightening torque (**10 Nm ± 1**).

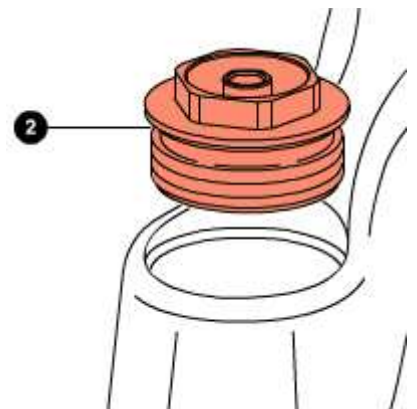

Restore the correct air pressure (see settings).

Fit the protection cap (1).

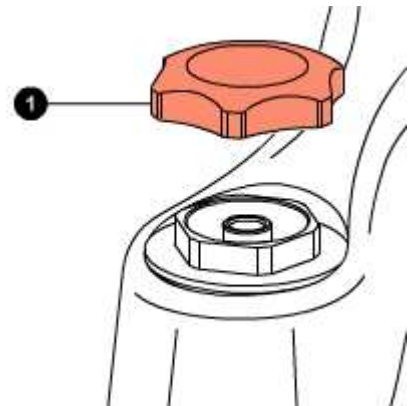

## Setting: General rules for calibration

By carefully calibrating the damping system you can get the maximum performance out of the same.

This paragraph indicates the sequence of operations to perform to set up the Marzocchi forks correctly.

In order to find the best settings for you, you will need to try several times to understand where and how to make adjustments. When doing so, please ride in an open area, free from traffic, obstacles and other hazards.

The optimal setting is influenced by the geometry of the frame of the mountain bike, the weight of the cyclist, the type of terrain the bike will be used on and the type of obstacles you have to deal with, but also by subjective factors associated with your riding style; therefore it is impossible to provide objective data on the desired settings.

Nevertheless by carefully following the instructions below you will soon be able to find the optimal setting for you.

The shock absorber must be calibrated simply by using one adjuster at a time, following the order explained, noting the operations and any result step-by-step.

**During setting don't force the adjusters beyond their limit of travel and don't exceed the max recommended air pressure.**

**To keep the pressure inside the fork's legs, only use the special MARZOCCHI pump with pressure gauge.**

**The use of any other pump can compromise the inflating operation and cause malfunction or damage to the fork, resulting in an accident, personal injury or death.**

*Once the correct setting has been found, we recommend noting the number of clicks or turns of the adjuster with respect to the "fully closed" position (adjuster fully clockwise) for a faster re-setting of your fork in case of need.*

## Setting: SAG

SAG means the fork bottoming under the biker's weight.

How to measure the SAG:

Follow these simple steps to measure the SAG.

On the leg portion of the fork, measure the distance between the lower crown and the dust seal (see Picture **A**). Note this value as "**H1**".

While sitting on the bike, repeat the measurement (see picture **B**). Note this value as "**H2**".

**SAG = H1 - H2**

How to find the best percent SAG:

The best percent SAG is 15-20% for Cross-country and All Mountain forks and 25-30% for Freeride and Downhill forks.

In order to calculate the best SAG for your own fork, you will need to make the following calculation:

**SAG = T x S** (**T** = total travel; **S** = suggested sinking percentage).

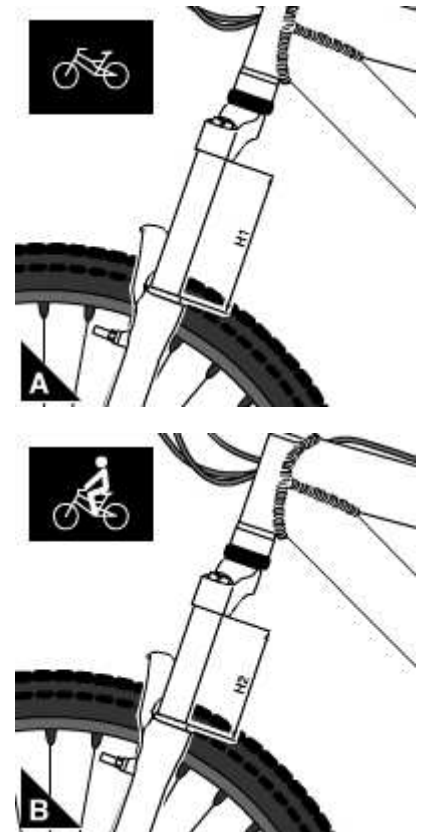

## Setting: Rebound adjustment

### Right fork leg:

With the rebound adjuster you can control the return speed of the fork after compression.

The right rebound speed setting makes the bike stable letting it follow the variations in the terrain and any obstacles.

If the fork setting is too reactive this will make the rear suspension instable and the mountain bike will have a tendency to snake. A too slow setting however will cause problems when dealing with multiple obstacles where the suspension can't return to its fully extended position fast enough between one obstacle and the next.

Turning adjuster (**A**) clockwise increases the hydraulic damping making the fork slower during the rebound phase.

Turning adjuster (**A**) counter-clockwise decreases the hydraulic damping making the fork more reactive during the rebound phase.

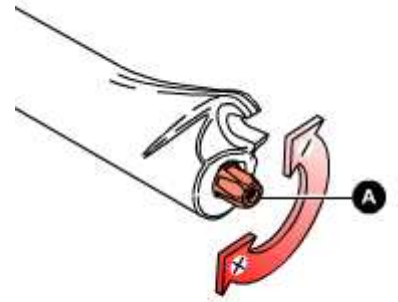

**Do not force the adjuster beyond its limit of travel.**

## Tightening torques

Components	Tightening torque (Nm)
Adjuster locking screws	2±0,5
Fork leg top caps	10±1
Pumping element/cartridge bottom nuts	10±1

## Air pressures

### Positive air pressure

User weight		Air pressure	
kg.	lb.	bar	psi
55 - 70	121 - 154	2,00 - 2,75	2.900,00 - 3.987,50
70 - 80	154 - 176	2,40 - 3,10	3.480,00 - 4.495,00
80 - 95	176 - 209	2,90 - 3,80	4.205,00 - 5.510,00
95 - 110+	209 - 242	3,60 - 4,50	5.220,00 - 6.525,00

### Preload air pressure

User weight		Air pressure	
kg.	lb.	bar	psi
0 - 110+	0 - 242	0 - 1,00	0,00 - 1.450,00

## Gran Fondo 2 - 105 - Oil levels

Position	Oil type	Quantity (cc)
Right fork leg	SAE 7,5 - 550013	125
Left fork leg	SAE 7,5 - 550013	125

## Gran Fondo 2 - 120 - Oil levels

Position	Oil type	Quantity (cc)
Right fork leg	SAE 7,5 - 550013	125
Left fork leg	SAE 7,5 - 550013	125



**Diagnostics**

Finding the problem	Finding the possible cause	Possible solutions proposed
Fork doesn't get full travel	Spring rate too stiff	Change to softer spring rate
Fork has too much sag	Spring rate too soft	Change to stiffer spring rate
Fork has too much sag	Spring rate too soft	Increase spring preload
Fork has too much sag	Spring rate too soft	Increase spring preload by replacing the preload tube
Fork is "sticky"; fork does not perform as new	Dirty sealing rings; fork needs to be serviced	Renew all seals
Fork is too soft, needs more than the maximum preload	Spring rate too soft	Change to stiffer spring rate
Front wheel tends to tuck under while turning left or right	Spring rate too soft	Change to stiffer spring rate
Heavy amount of oil on stanchions; oil dripping down legs	Sealing rings damaged	Renew all seals
Heavy amount of oil on stanchions; oil dripping down legs	The stanchion tubes could be damaged	Have the stanchions be checked
Loss of sensitivity	Sliding bushes worn	Renew the sliding bushes
Oil leaking from the bottom of the fork leg	Bottom nut/screw loose	Tighten the nut or screw
Oil ring on stanchions	Sealing rings dirty	Renew all seals